

Article number: 12755000030110

Description: KLEE-coil 755 000 030.110
M3 Steel, zinc-pl. & chr. blue

Measures

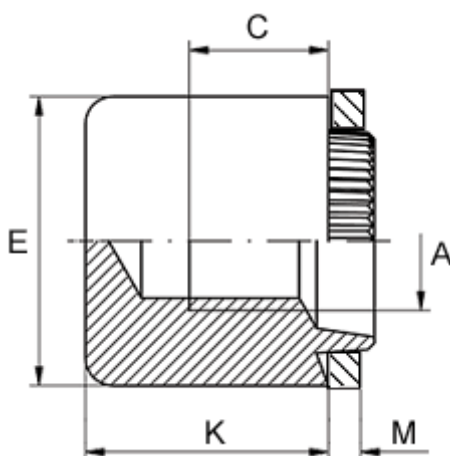

Female thread A	= M3
Height K	= 9.0
Min thread length C	= 3.0
Outer diameter E	= 8.0
Plate thickness	= 4.1 to 4.3
Recommended bore diameter for extreme load	= 6.0
Recommended bore diameter for normal use	= 6.0